

Umlenkzwischenplatte NG25

Typ

Lochbild DIN 24340 Form A / ISO 4401

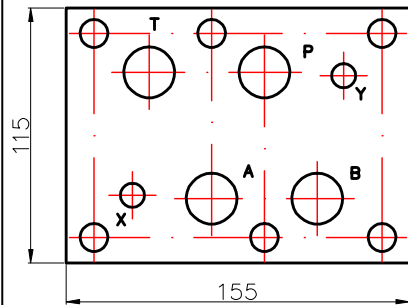
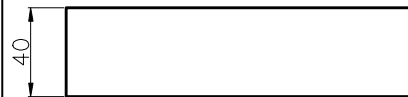
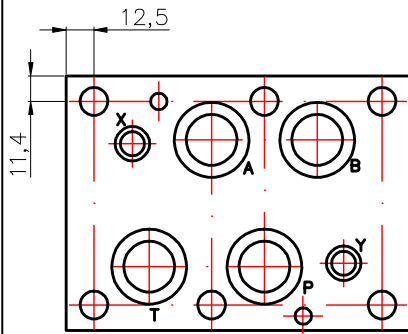

Material
Aluminium
AlCuMg1 F38

Betriebsdruck
max. 315 bar

incl. O-Ringe
4 Stk. 29x2,5
3 Stk. 12x2
und Stopfen

Symbol:

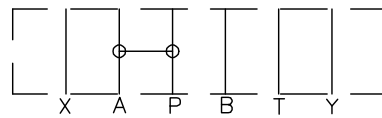

NG25 P-A

8250280

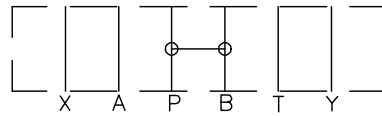

NG25 P-B

8250281

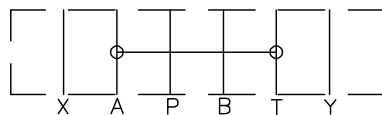

NG25 T-A

8250282

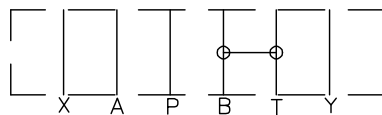

NG25 T-B

8250283

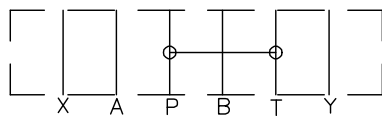

NG25 P-T

8250284

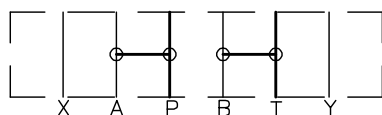

NG25 P-A/T-B

8250285

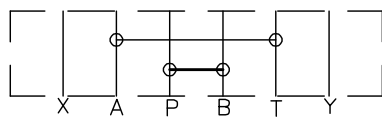

NG25 P-B/T-A

8250286

Sonderausführungen auf Anfrage

Stärke (40mm) ist je nach Ausführung verschieden

Änderungen vorbehalten

NOVOTEC spol. s r.o.

SK-919 02 Dolné Orešany č.435
Slovakia

Tel. 00421-33-55 82 135
E-mail: novotec@novotec.sk
www.novotec.sk

Seite